

# バイコン1号マンホール製品図 s=1:20

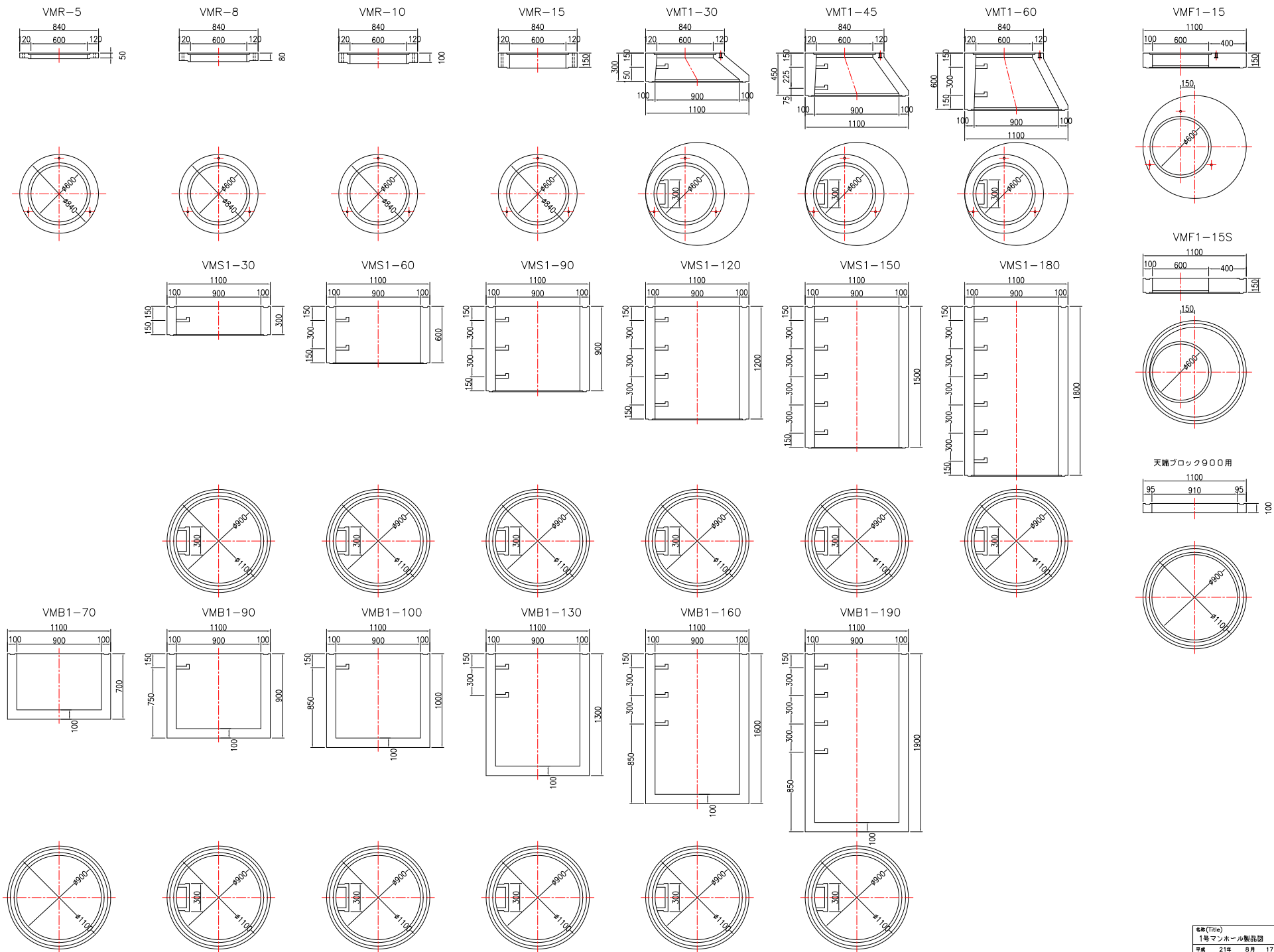

# バイコン2号マンホール製品図 s=1:20

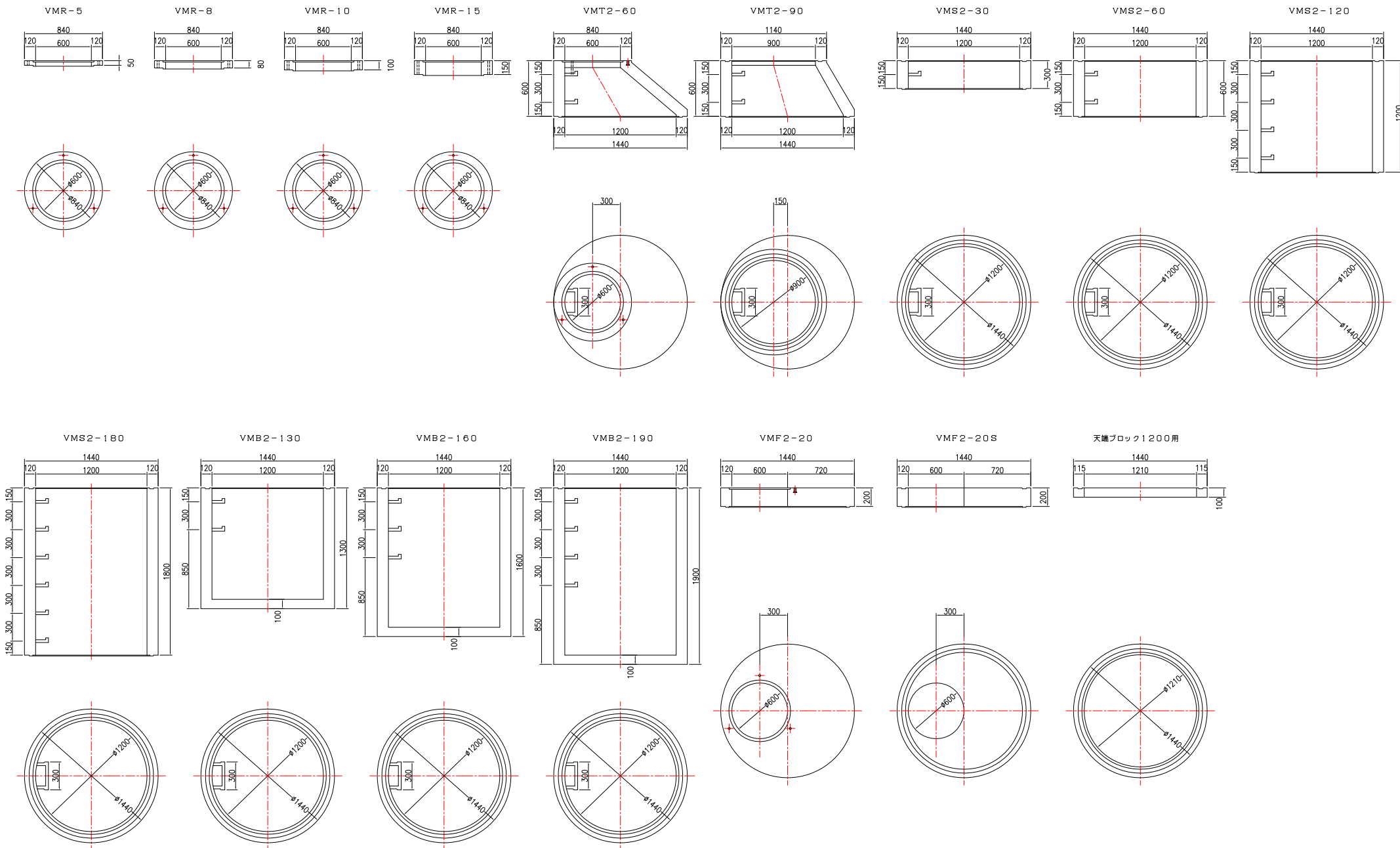

バイコンオーバーマンホール製品図 S=1:20

VMR-5

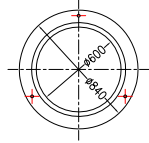
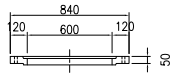

VMR-8

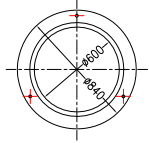
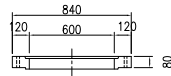

VMR-10

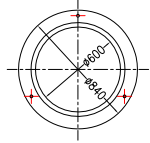
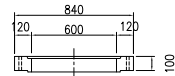

VMR-15

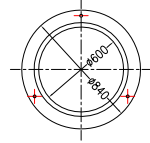
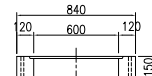

OMF-20

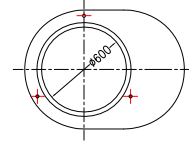
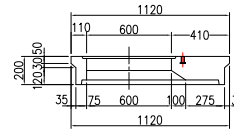

OMT-45

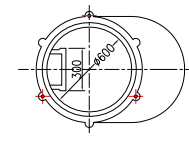
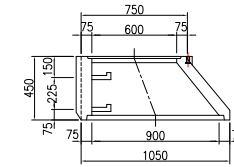

OMT-60

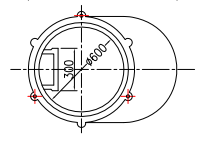
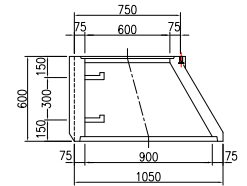

OMS-30

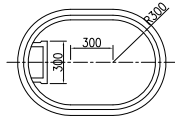
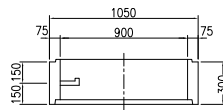

OMS-60

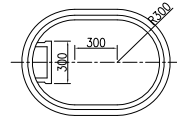
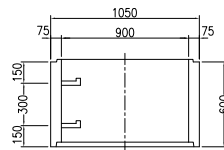

OMS-90

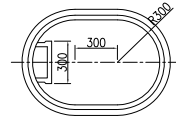
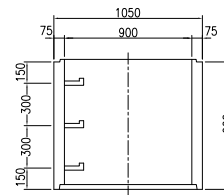

OMB-67

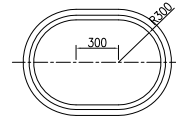
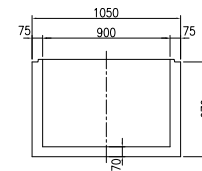

OMB-87

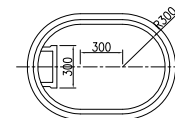
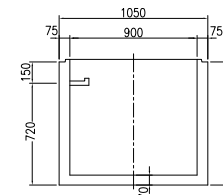

OMB-97

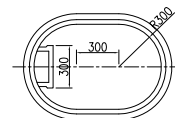
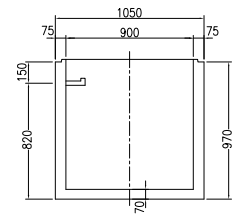

OMB-127

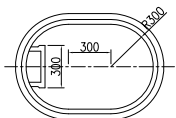
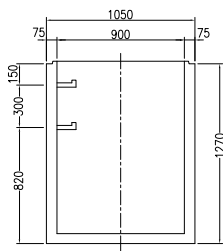

OMB-70B

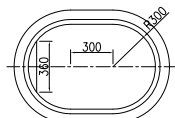
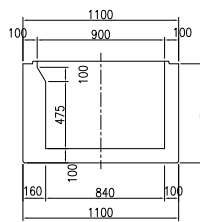

# バイコンφ600マンホール製品図 s=1:20

調整ブロック  
VMR-5

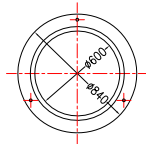
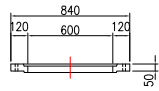

調整ブロック  
VMR-8

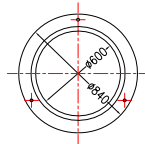
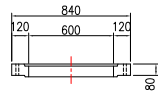

調整ブロック  
VMR-10

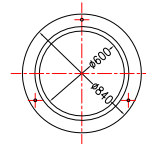
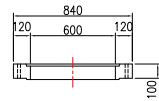

調整ブロック  
VMR-15

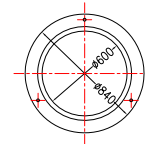
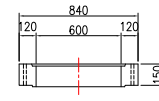

斜壁ブロック  
VT-20

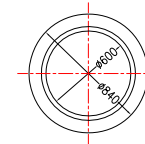
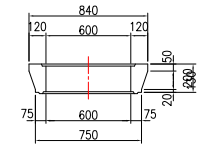

直壁ブロック  
VS-30

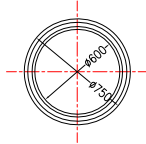
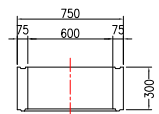

直壁ブロック  
VS-60

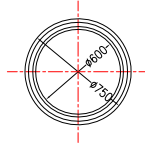
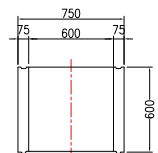

底付ブロック  
VB-67

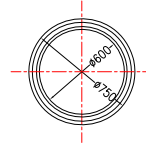
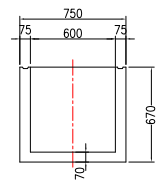

底付ブロック  
VB-67A

